

DATA SHEET

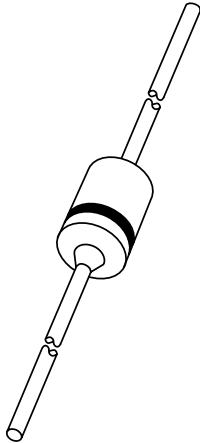

BYD33 series Fast soft-recovery controlled avalanche rectifiers

Product specification
Supersedes data of 1996 Jun 05

1996 Sep 18

Fast soft-recovery controlled avalanche rectifiers

BYD33 series

FEATURES

- Glass passivated
- High maximum operating temperature
- Low leakage current
- Excellent stability
- Guaranteed avalanche energy absorption capability
- Available in ammo-pack.

DESCRIPTION

Cavity free cylindrical glass package through Implotec™(1) technology. This package is hermetically sealed

and fatigue free as coefficients of expansion of all used parts are matched.

(1) Implotec is a trademark of Philips.

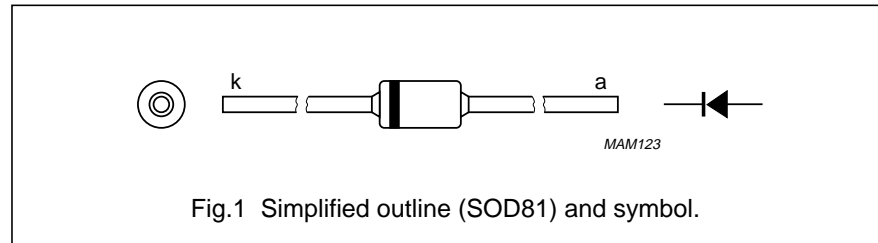

LIMITING VALUES

In accordance with the Absolute Maximum Rating System (IEC 134).

SYMBOL	PARAMETER	CONDITIONS	MIN.	MAX.	UNIT
V _{RRM}	repetitive peak reverse voltage				
	BYD33D		–	200	V
	BYD33G		–	400	V
	BYD33J		–	600	V
	BYD33K		–	800	V
	BYD33M		–	1000	V
	BYD33U BYD33V		–	1200 1400	V V
V _R	continuous reverse voltage				
	BYD33D		–	200	V
	BYD33G		–	400	V
	BYD33J		–	600	V
	BYD33K		–	800	V
	BYD33M		–	1000	V
	BYD33U BYD33V		–	1200 1400	V V
I _{F(AV)}	average forward current	T _{tp} = 55 °C; lead length = 10 mm; see Figs 2 and 3; averaged over any 20 ms period; see also Figs 10 and 11	–	1.30	A
	BYD33D to M BYD33U and V		–	1.26	A
I _{F(AV)}	average forward current	T _{amb} = 65 °C; PCB mounting (see Fig.19); see Figs 4 and 5; averaged over any 20 ms period; see also Figs 10 and 11	–	0.70	A
	BYD33D to M BYD33U and V		–	0.67	A
I _{FRM}	repetitive peak forward current	T _{tp} = 55 °C; see Figs 6 and 7	–	12	A
	BYD33D to M BYD33U and V		–	11	A

Fast soft-recovery controlled avalanche rectifiers

BYD33 series

SYMBOL	PARAMETER	CONDITIONS	MIN.	MAX.	UNIT
I_{FRM}	repetitive peak forward current	$T_{amb} = 65\text{ °C}$; see Figs 8 and 9	–	7	A
	BYD33D to M BYD33U and V			6	A
I_{FSM}	non-repetitive peak forward current	$t = 10\text{ ms}$ half sine wave; $T_j = T_{j\max}$ prior to surge; $V_R = V_{RRM\max}$	–	20	A
E_{RSM}	non-repetitive peak reverse avalanche energy	$L = 120\text{ mH}$; $T_j = T_{j\max}$ prior to surge; inductive load switched off	–	10	mJ
	BYD33D to J BYD33K to V			7	mJ
T_{stg}	storage temperature		–65	+175	°C
T_j	junction temperature	see Figs 12 and 13	–65	+175	°C

ELECTRICAL CHARACTERISTICS

$T_j = 25\text{ °C}$ unless otherwise specified.

SYMBOL	PARAMETER	CONDITIONS	MIN.	TYP.	MAX.	UNIT			
V_F	forward voltage	$I_F = 1\text{ A}$; $T_j = T_{j\max}$; see Figs 14 and 15	–	–	1.1	V			
		$I_F = 1\text{ A}$; see Figs 14 and 15	–	–	1.3	V			
$V_{(BR)R}$	reverse avalanche breakdown voltage	$I_R = 0.1\text{ mA}$				V			
	BYD33D						300	–	–
	BYD33G						500	–	–
	BYD33J						700	–	–
	BYD33K						900	–	–
	BYD33M						1100	–	–
	BYD33U						1300	–	–
BYD33V	1500	–	–						
I_R	reverse current	$V_R = V_{RRM\max}$; see Fig.16	–	–	1	µA			
		$V_R = V_{RRM\max}$; $T_j = 165\text{ °C}$; see Fig.16	–	–	100	µA			
t_{rr}	reverse recovery time	when switched from $I_F = 0.5\text{ A}$ to $I_R = 1\text{ A}$; measured at $I_R = 0.25\text{ A}$ see Fig.21	–	–	250	ns			
	BYD33D to J				300	ns			
	BYD33K and M BYD33U and V				500	ns			
C_d	diode capacitance	$f = 1\text{ MHz}$; $V_R = 0\text{ V}$; see Figs 17 and 18	–	20	–	pF			

Fast soft-recovery controlled avalanche rectifiers

BYD33 series

SYMBOL	PARAMETER	CONDITIONS	MIN.	TYP.	MAX.	UNIT
$\left \frac{dI_R}{dt} \right $	maximum slope of reverse recovery current	when switched from $I_F = 1 \text{ A}$ to $V_R \geq 30 \text{ V}$ and $dI_F/dt = -1 \text{ A}/\mu\text{s}$; see Fig.20	–	–	6	$\text{A}/\mu\text{s}$
	BYD33D to J					
	BYD33K to V		–	–	5	$\text{A}/\mu\text{s}$

THERMAL CHARACTERISTICS

SYMBOL	PARAMETER	CONDITIONS	VALUE	UNIT
$R_{th \text{ j-tp}}$	thermal resistance from junction to tie-point	lead length = 10 mm	60	K/W
$R_{th \text{ j-a}}$	thermal resistance from junction to ambient	note 1	120	K/W

Note

1. Device mounted on an epoxy-glass printed-circuit board, 1.5 mm thick; thickness of Cu-layer $\geq 40 \mu\text{m}$, see Fig.19. For more information please refer to the "General Part of associated Handbook".

Fast soft-recovery
controlled avalanche rectifiers

BYD33 series

GRAPHICAL DATA

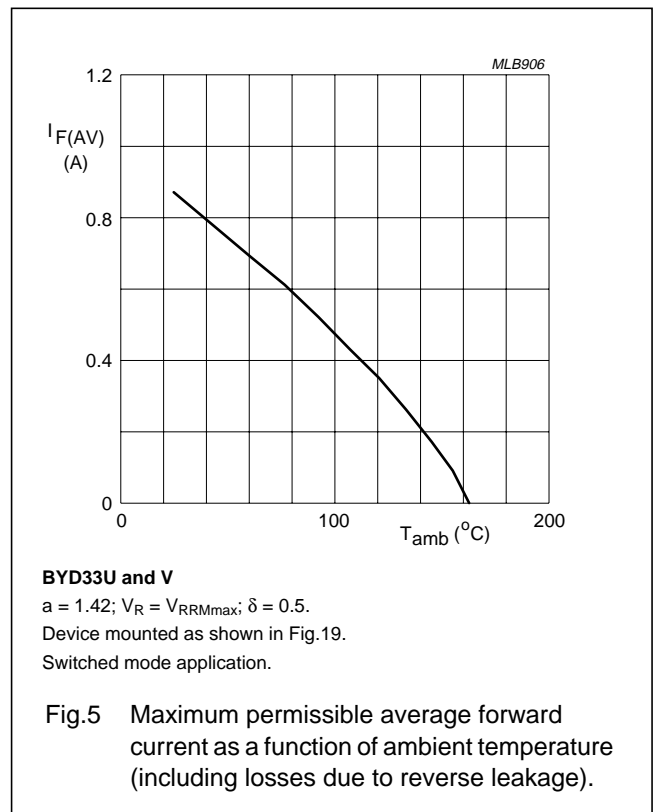
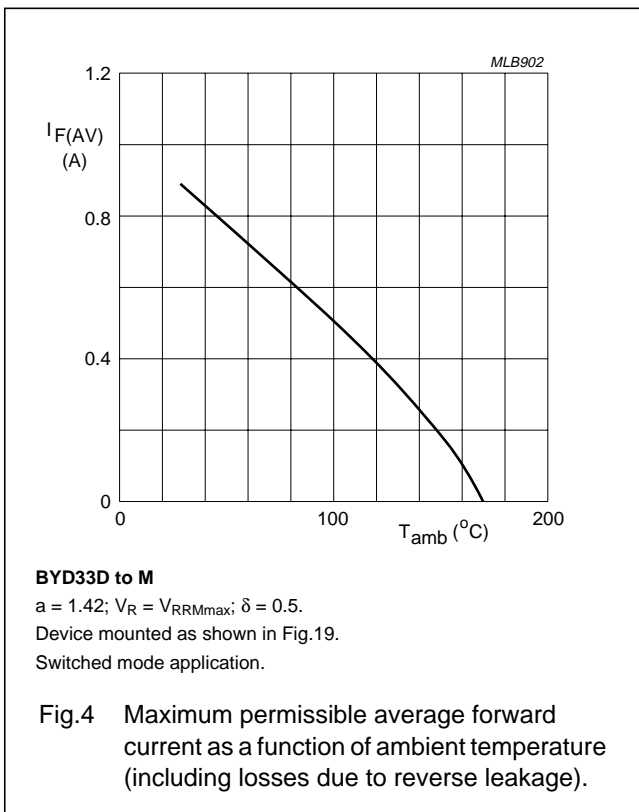
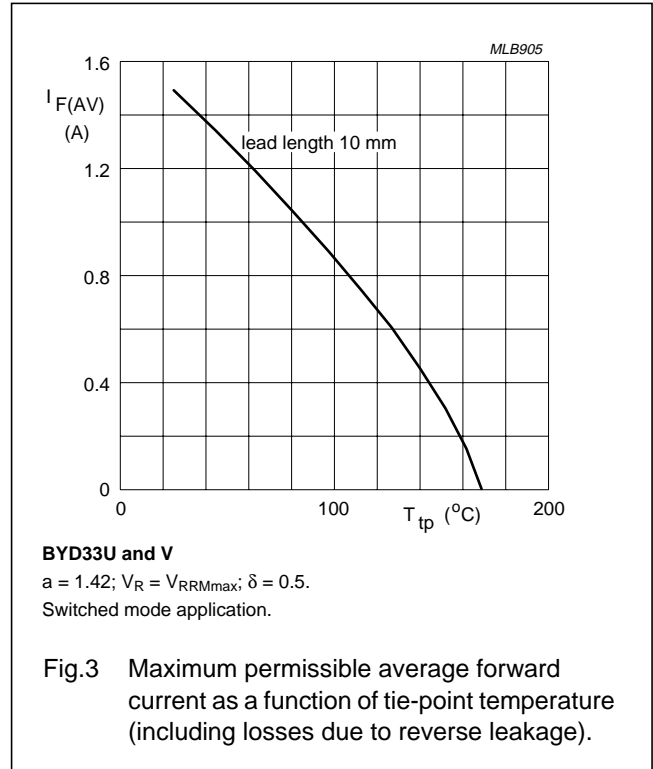
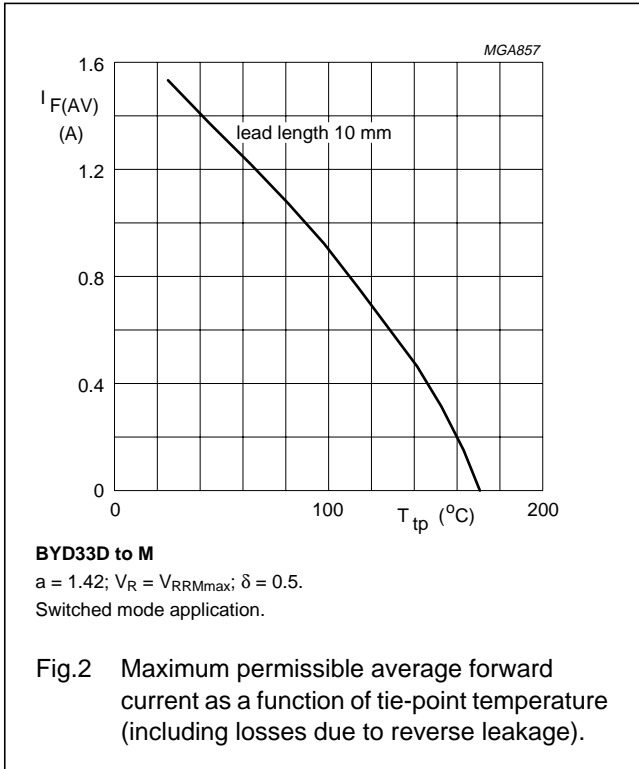

Fast soft-recovery
controlled avalanche rectifiers

BYD33 series

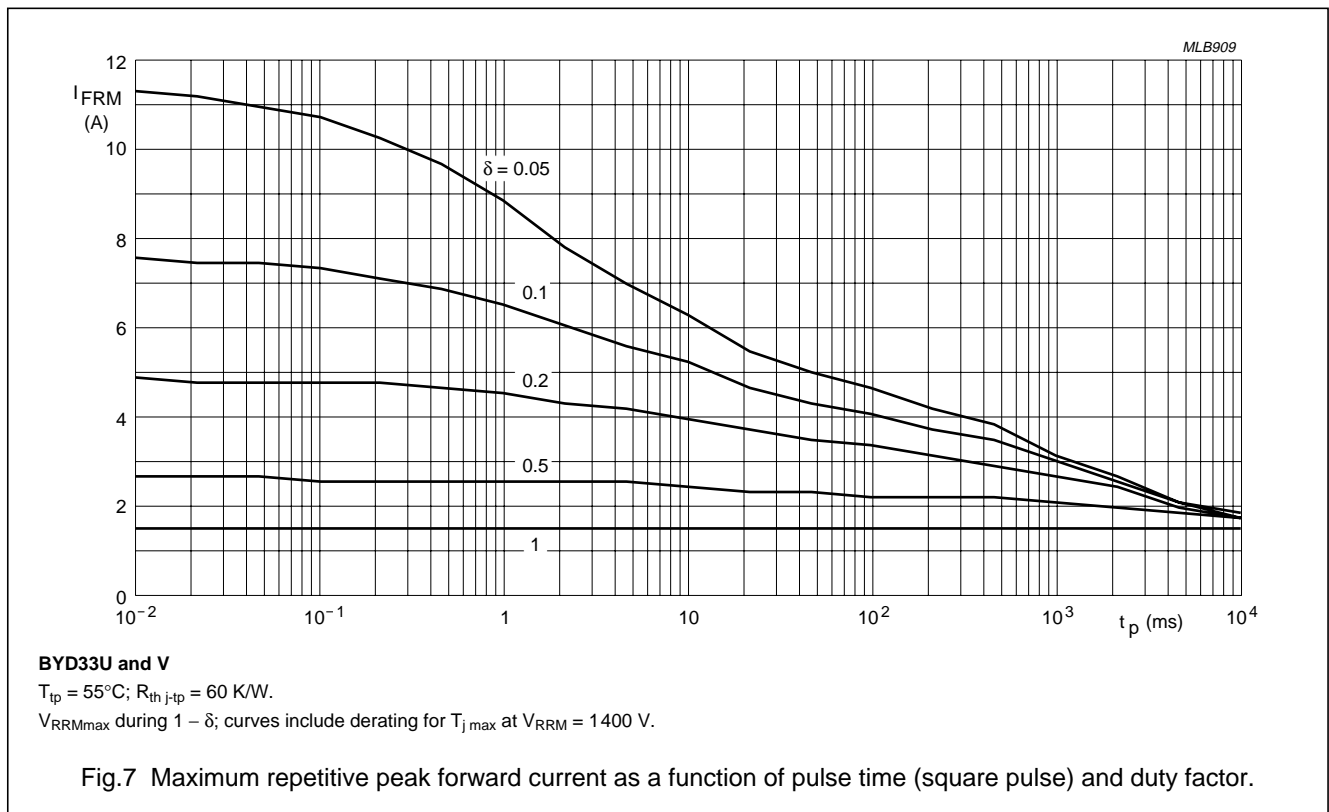
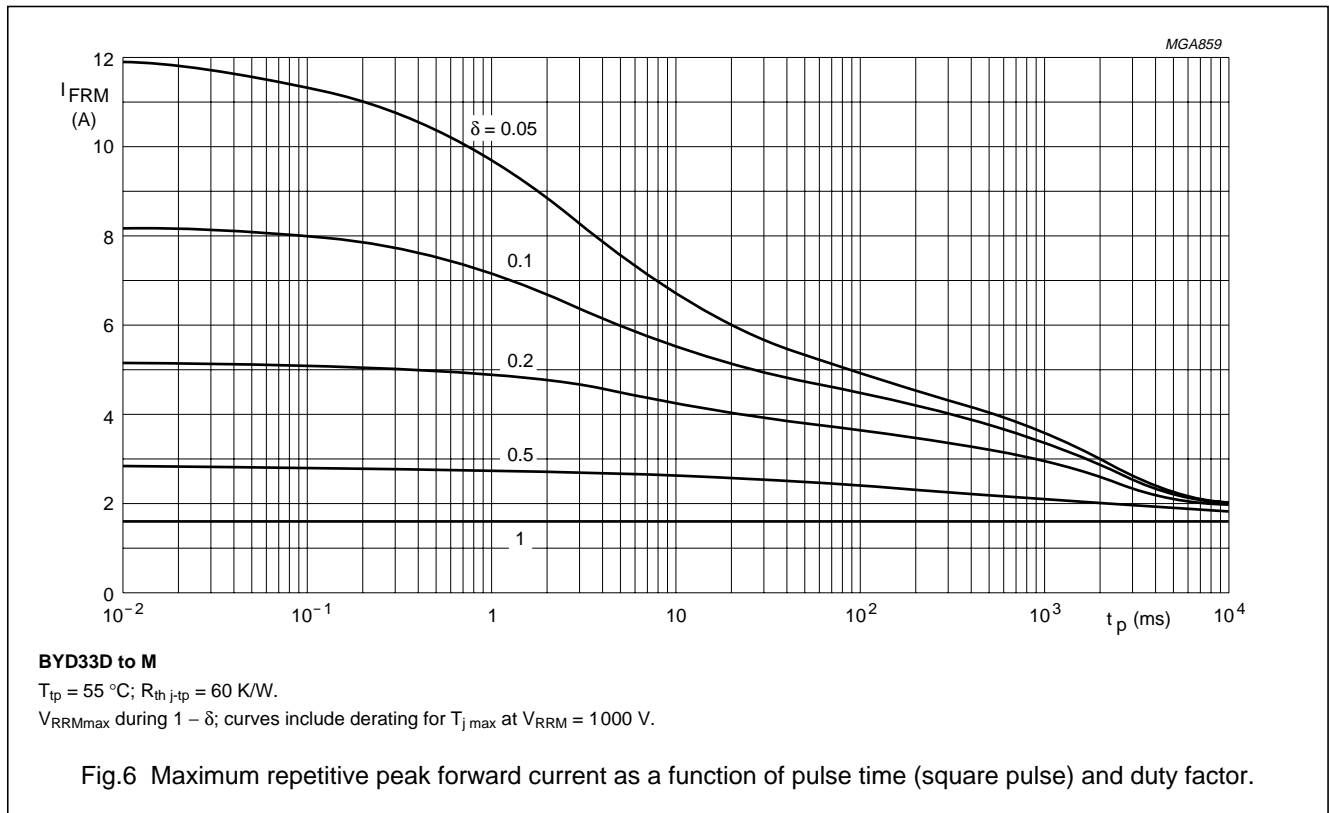

Fast soft-recovery
controlled avalanche rectifiers

BYD33 series

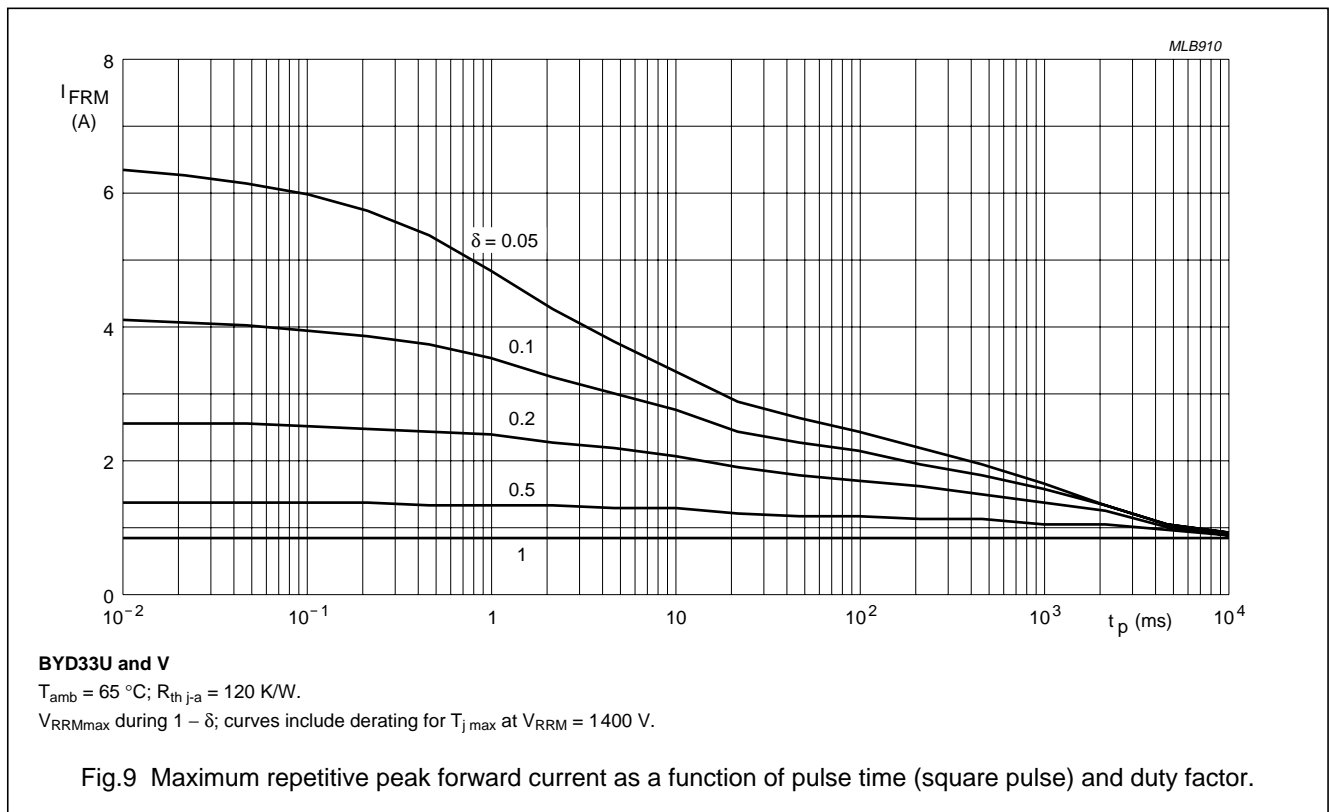
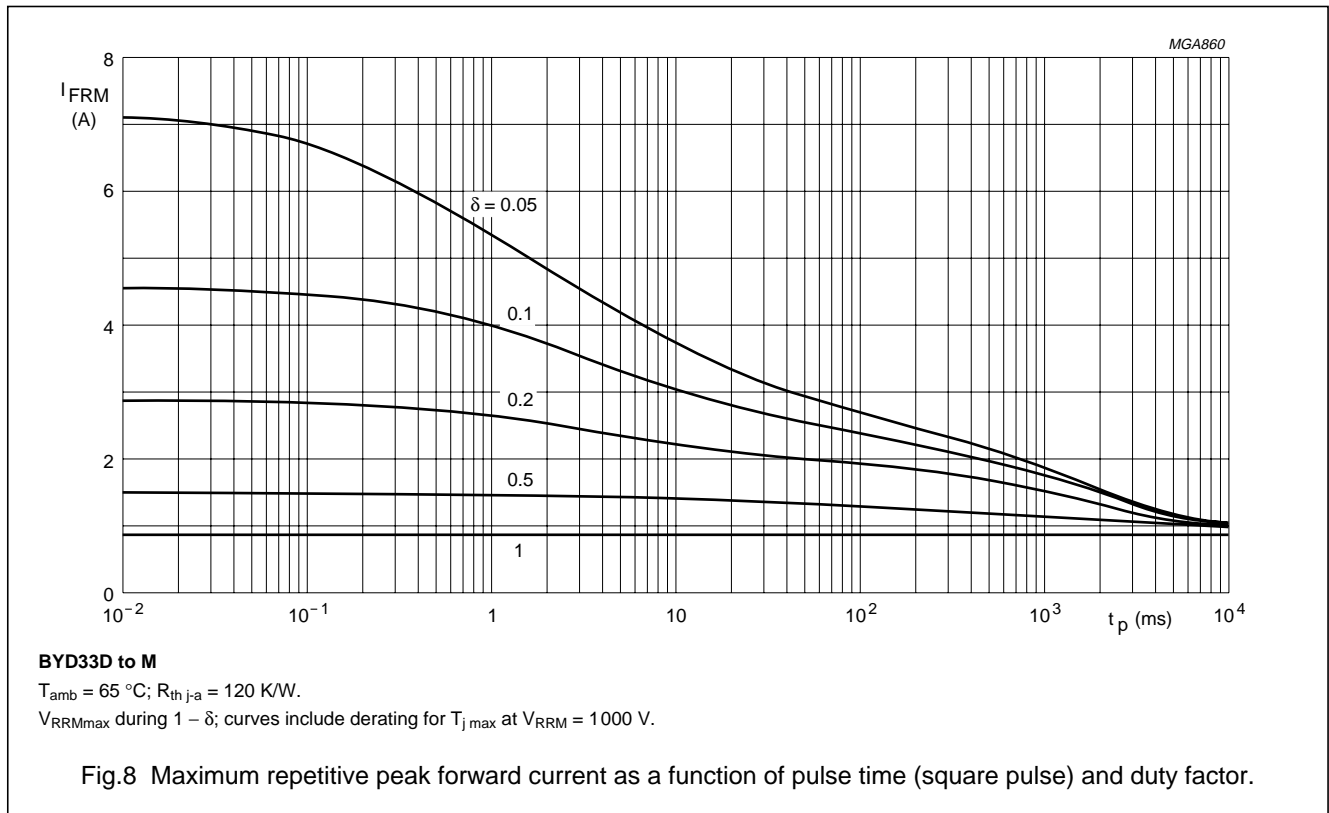

Fast soft-recovery controlled avalanche rectifiers

BYD33 series

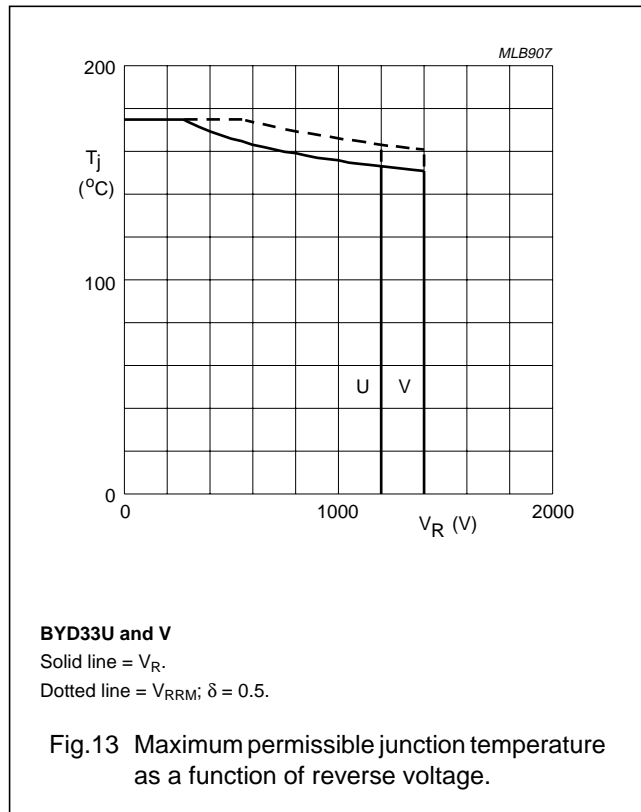
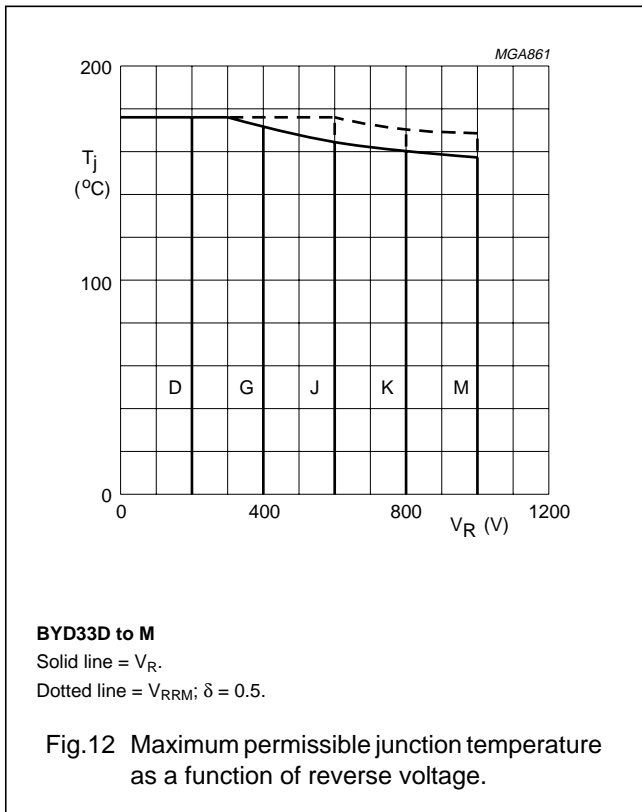
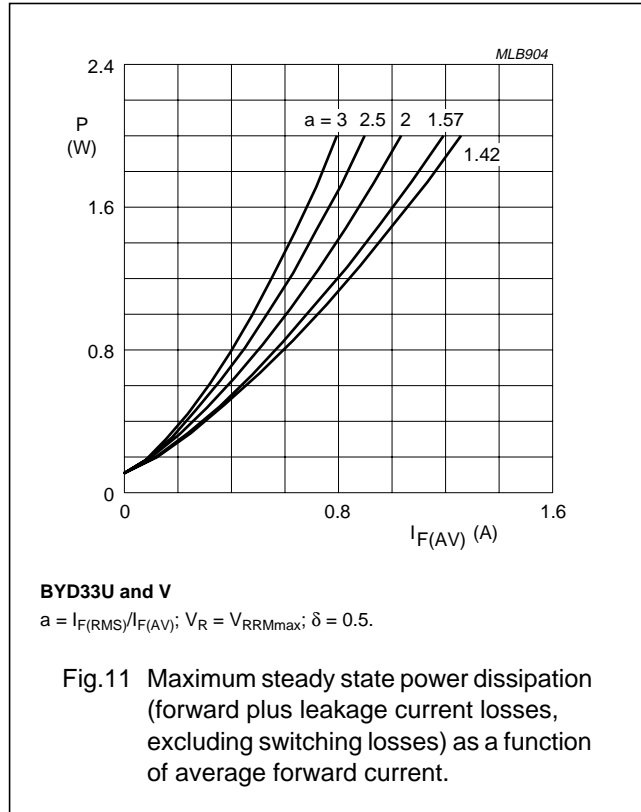
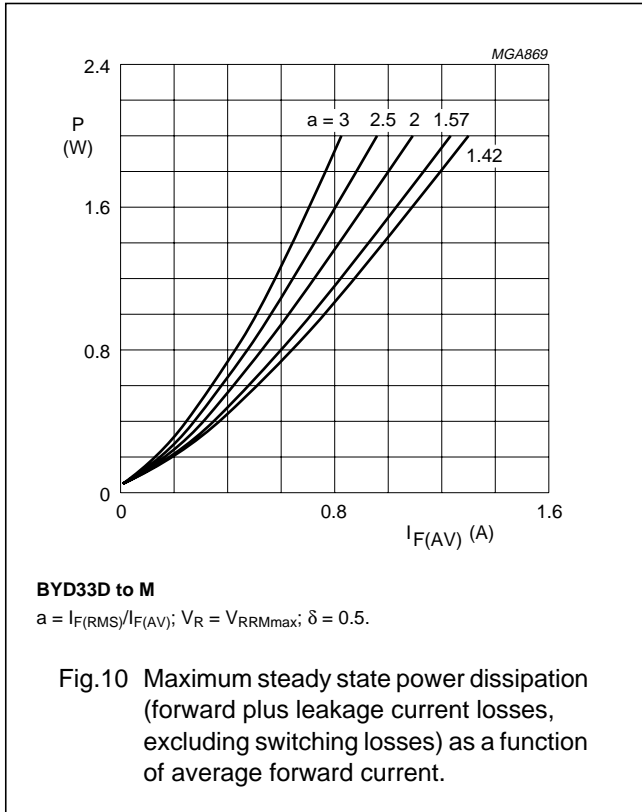

Fast soft-recovery
controlled avalanche rectifiers

BYD33 series

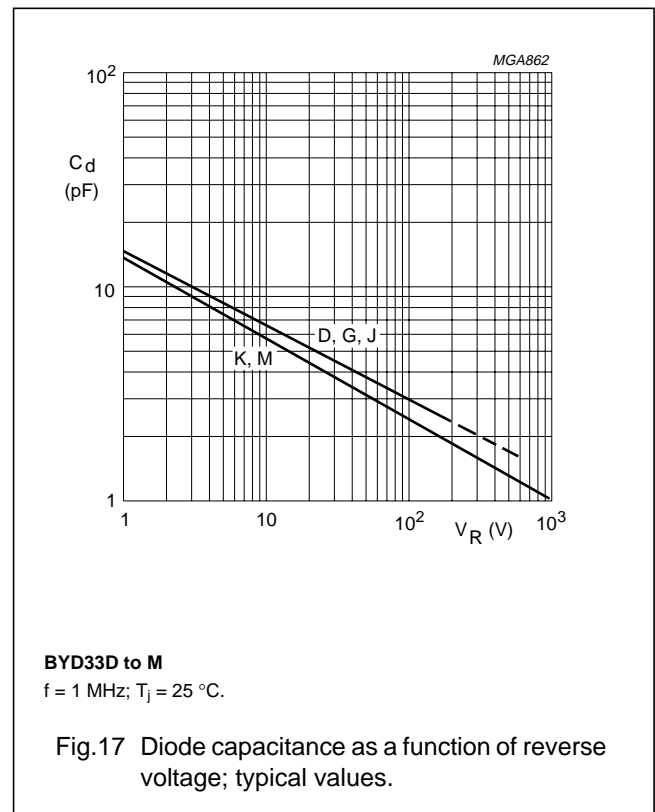
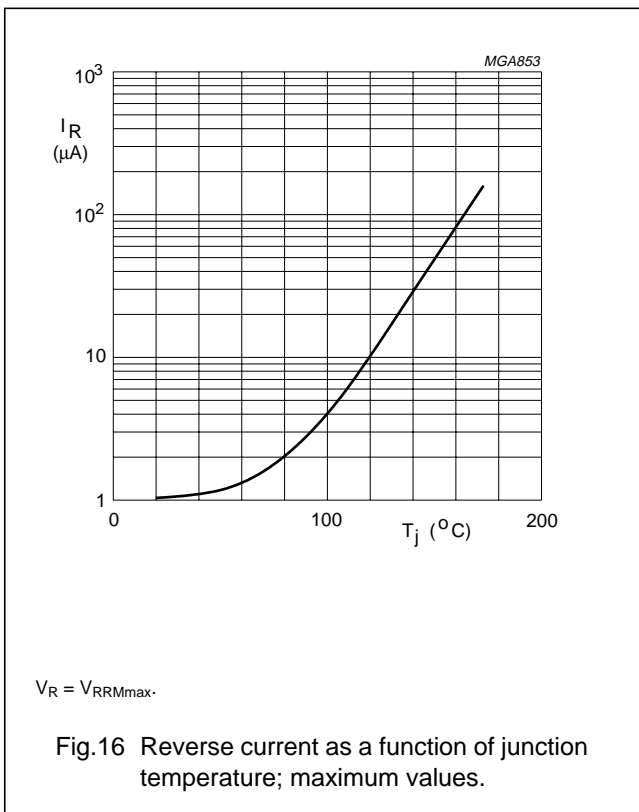
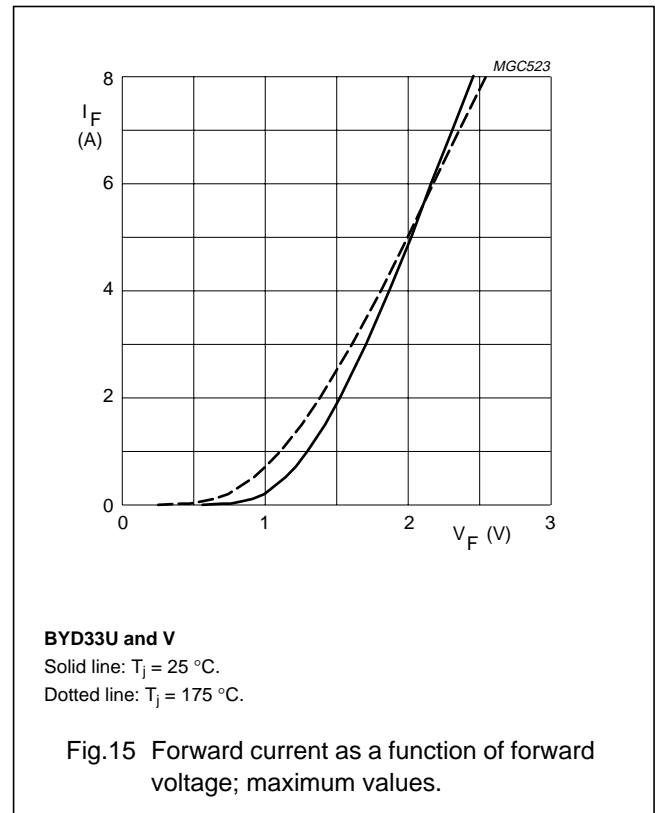
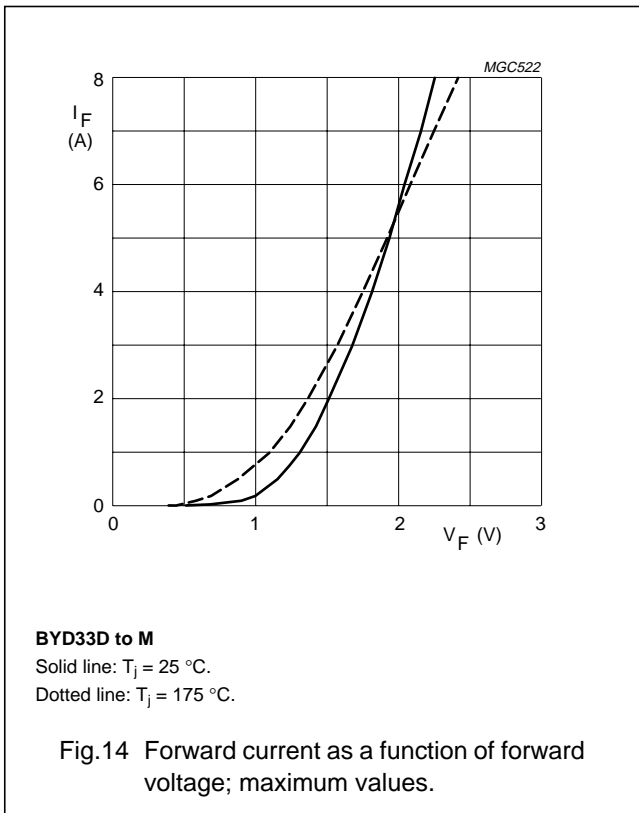

Fast soft-recovery
controlled avalanche rectifiers

BYD33 series

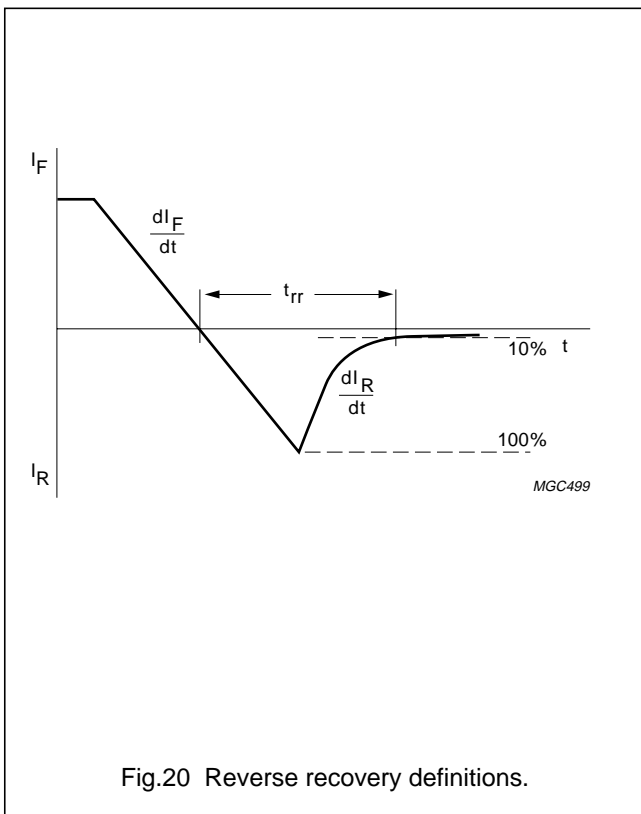
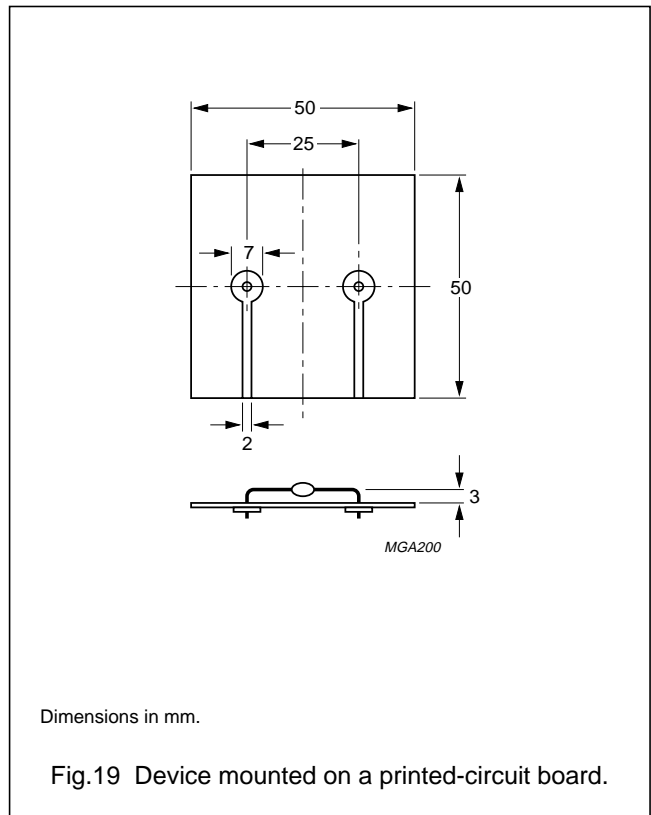
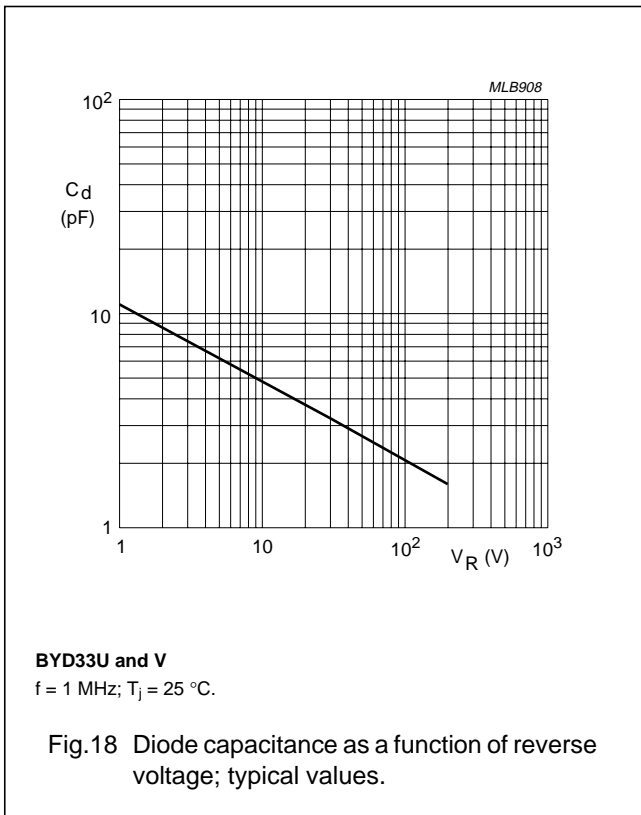

Fast soft-recovery controlled avalanche rectifiers

BYD33 series

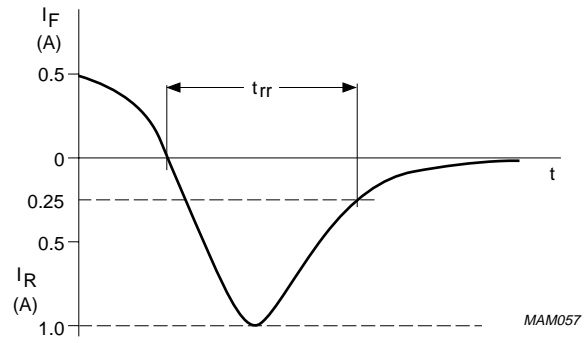
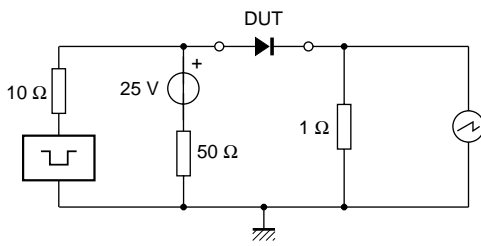

Input impedance oscilloscope: 1 M Ω , 22 pF; $t_r \leq 7$ ns.
Source impedance: 50 Ω ; $t_r \leq 15$ ns.

Fig.21 Test circuit and reverse recovery time waveform and definition.

Fast soft-recovery
controlled avalanche rectifiers

BYD33 series

PACKAGE OUTLINE

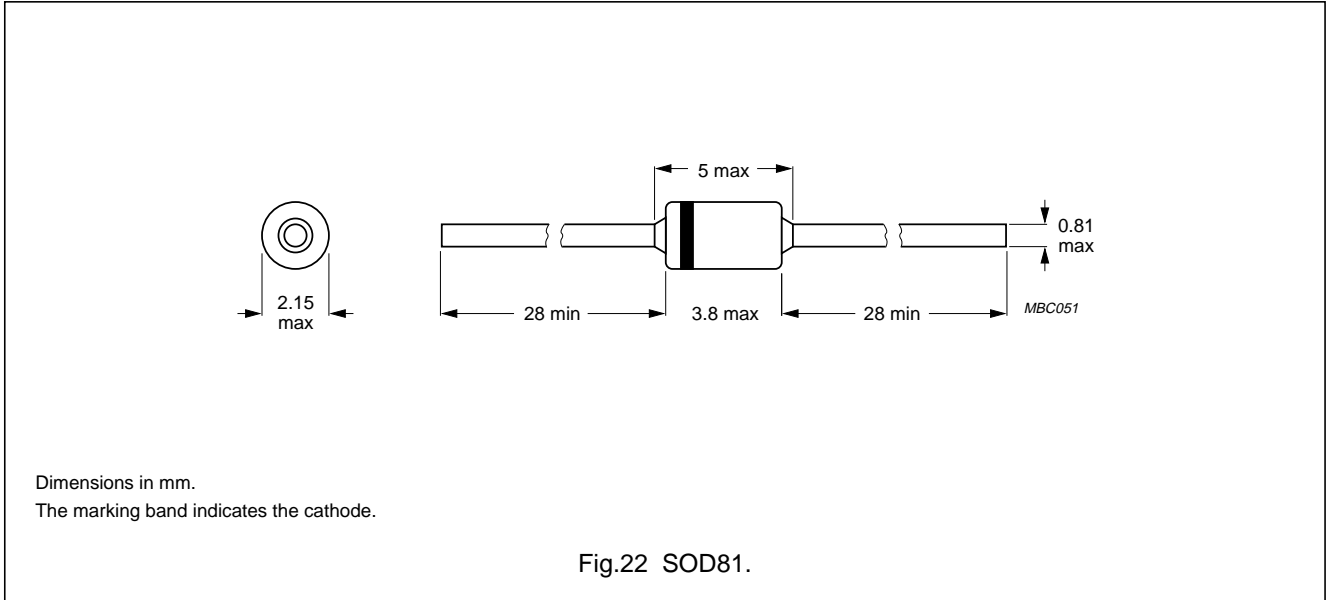

DEFINITIONS

Data Sheet Status	
Objective specification	This data sheet contains target or goal specifications for product development.
Preliminary specification	This data sheet contains preliminary data; supplementary data may be published later.
Product specification	This data sheet contains final product specifications.
Limiting values	
Limiting values given are in accordance with the Absolute Maximum Rating System (IEC 134). Stress above one or more of the limiting values may cause permanent damage to the device. These are stress ratings only and operation of the device at these or at any other conditions above those given in the Characteristics sections of the specification is not implied. Exposure to limiting values for extended periods may affect device reliability.	
Application information	
Where application information is given, it is advisory and does not form part of the specification.	

LIFE SUPPORT APPLICATIONS

These products are not designed for use in life support appliances, devices, or systems where malfunction of these products can reasonably be expected to result in personal injury. Philips customers using or selling these products for use in such applications do so at their own risk and agree to fully indemnify Philips for any damages resulting from such improper use or sale.